

EXPOSURE GLAS

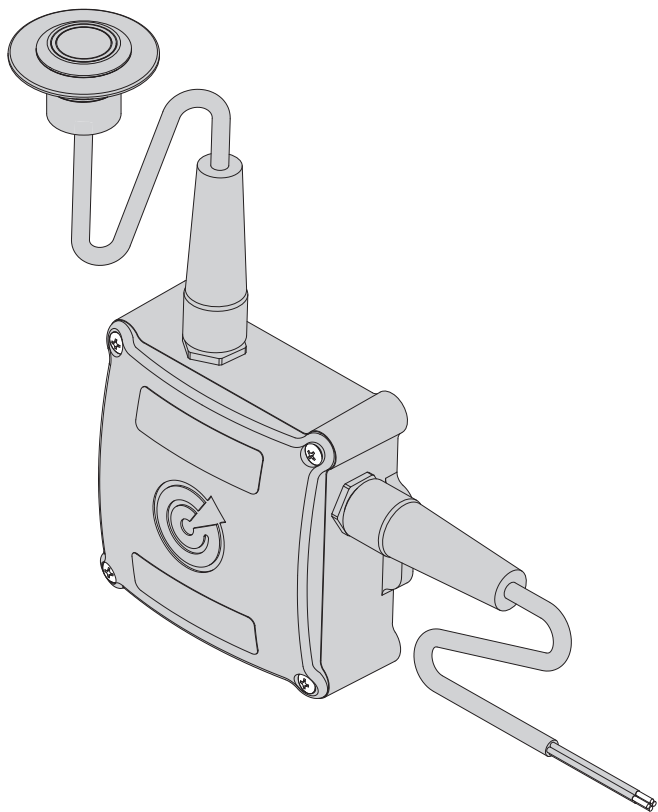

WIRELESS
SAFETY

GUARDIAN

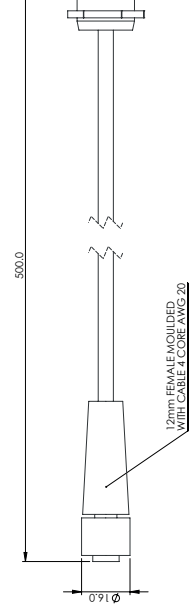
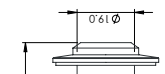
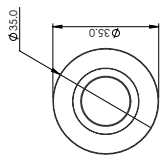

12mm FEMALE MOLDED WITH CABLE 4 CORE AWG 20

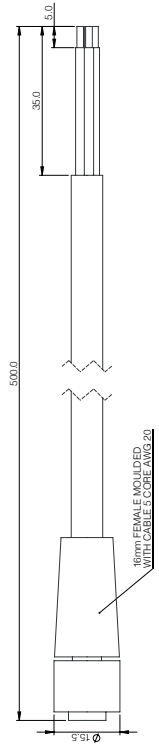

16mm FEMALE MOLDED WITH CABLE 5 CORE AWG 20

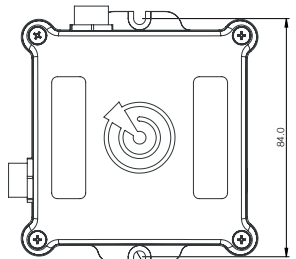
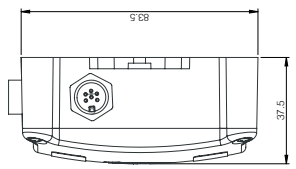

All dimensions are in mm

Control Switch with green and red indication LED

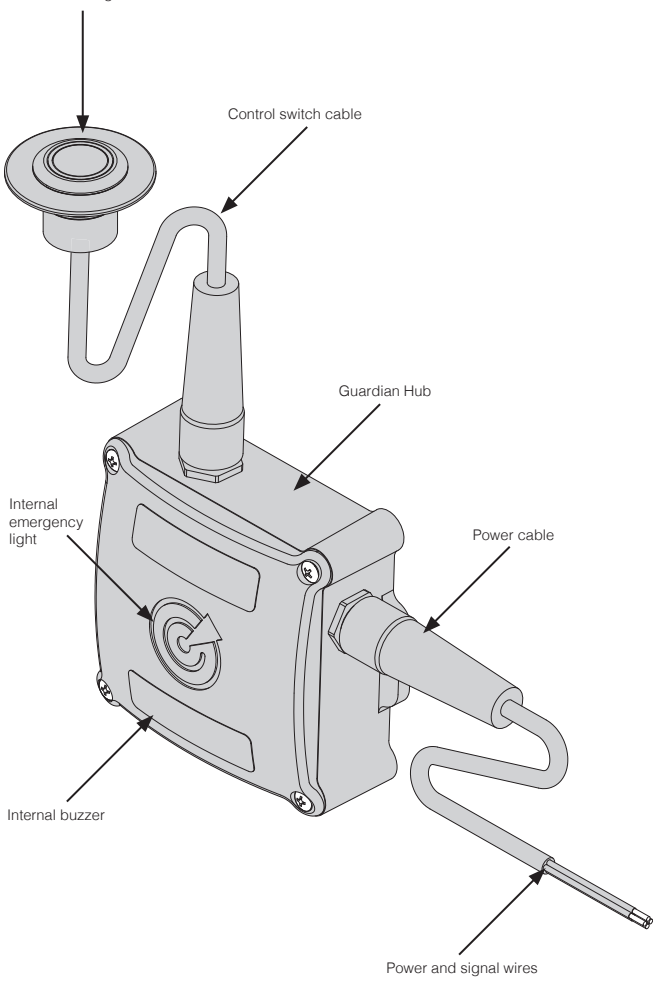

OLAS TRANSMITTERS

The OLAS TAG or the OLAS FLOAT-ON are considered OLAS transmitters. They emit a Bluetooth signal which is monitored by the OLAS receivers.

OLAS RECEIVERS

The OLAS receivers track the OLAS transmitters. OLAS receivers are:

1. Guardian
2. Core
3. OLAS Mobile application
4. Extender - This operates as a repeater to increase the range of the Guardian and Core

OLAS MOBILE APPLICATION

The OLAS mobile application allows the OLAS transmitters to be used as a MOB/proximity alarm if used solely with OLAS transmitters. When an OLAS transmitter goes out of range an alarm is set off and overboard screens are activated.

When the OLAS mobile application is connected to the Guardian or Core it allows greater control over the OLAS transmitters that are being tracked.

For iOS search for 'OLAS: Wireless Marine Safety' on the App Store.

For Android search for 'Exposure OLAS – Overboard Location Alert System' on the Google Play Store.

IMPORTANT INFORMATION

The Guardian has been designed for recreational marine use. The design conforms to appropriate Electromagnetic Compatibility (EMC) regulations but for optimal performance correct installation is required. For optimum performance the mobile device and the Guardian should be located at least 0.5 meters from any equipment transmitting radio signals including VHF Radios, antennas and cables.

GUARDIAN INSTALLATION

WARNING: Do not attempt to install the Guardian until you know that the power supply is switched OFF.

Where required use the supplied wire connectors which are suitable for connecting wire dimension 20-18AWG. If wire extensions are required use 20AWG or thicker wire.

Always connect your power supply after the main power switch to avoid current drainage when the boat is not in use.

Ensure all wire connections are waterproof using marine specific connectors, such as heat shrinkable butt splices.

DRILLING THE HOLE

Find a location to install the Guardian's control switch, either next to or near your existing kill switch then drill a 21mm (0.8") diameter hole.

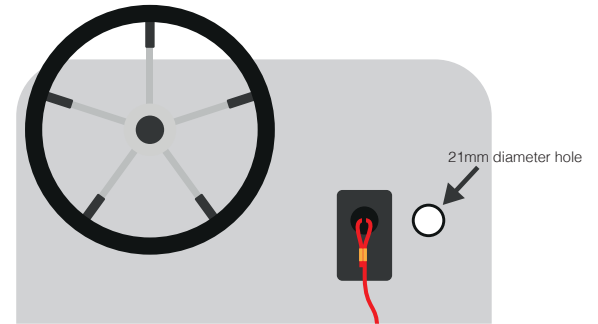

NOTE switch the orientation of the securing nut shown below, dependent on panel thickness:

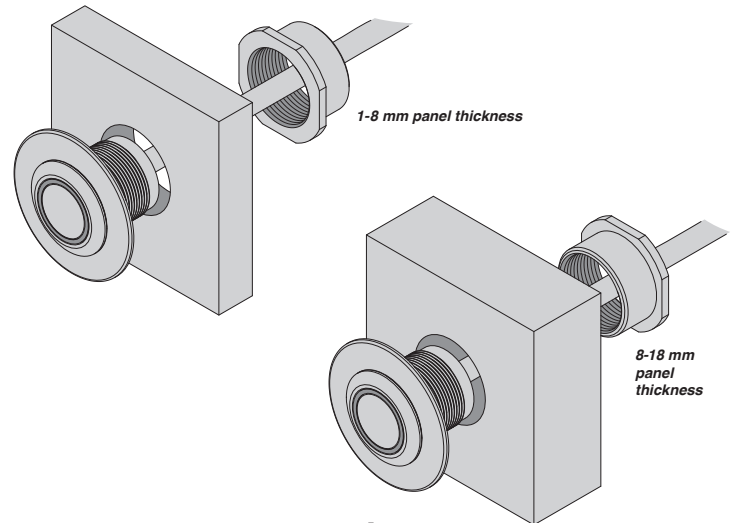

CONNECTING THE POWER WIRES (10-32VDC)

1. Connect power cable to Guardian hub.
2. Ensure Power supply is switched OFF.
3. Connect the white (+ or positive) wire to the positive voltage terminal
4. Connect the black (- or ground) wire to the negative voltage terminal
5. Install a 1-3 A fuse in line with the positive connection (fuse not supplied)

The Guardian uses a double throw relay enabling it to open or close any circuit. It has been designed to be connected alongside your existing kill switch and it is designed to perform the same function.

CONNECTING THE SIGNAL WIRES ALONGSIDE YOUR EXISTING KILL SWITCH

1. Check with your engine manufacture if the kill switch is operated by closing the circuit or opening the circuit. Most engines operate by closing the circuit to stop the engine. Close to stop systems should connect in parallel to your existing kill switch. Open to stop systems should connect in series to your existing kill switch.
2. There are 3 signal wires:
Grey= COMMON
Brown = CLOSE TO STOP
Purple = OPEN TO STOP
3. Connect the grey wire to the existing kill switches common wire
4. Connect the brown wire to the remaining kill switch wire if your system uses the close to stop system
5. Connect the purple wire to the remaining kill switch wire if your system uses the open to stop system
NOTE: ONLY two signal wire should be connected
6. Close off the remaining wire with the supplied end cap

SECURE THE GUARDIAN HUB

1. Find a location where the hub can be securely attached, and the power and switch wires can remain securely attached to the hub
2. The attachment screws provided are self-tapping for plastic / wood so can be screwed directly into the center console. Ensure attachment point is thicker than the attachment screws to avoid screwing through the panel
3. Secure the hub firmly into the center console

OPEN TO STOP

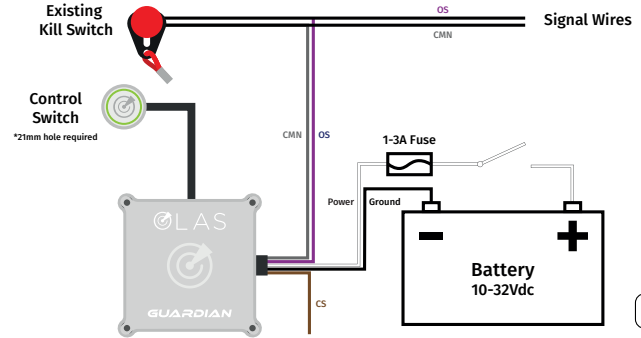

Input: 10-32Vdc ≈ 13-17mA

Volvo Penta

CLOSE TO STOP

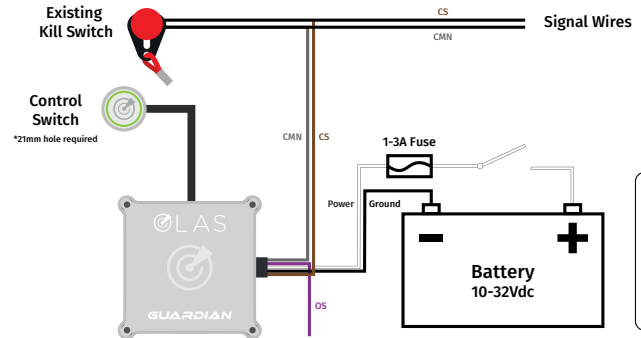

Input: 10-32Vdc ≈ 13-17mA

Yamaha
Suzuki
Evinrude
Tohatsu
Honda
Mercury

White — Power
Black — Ground

Purple — Open to stop (OS)
Brown — Close to stop (CS)
Grey — Common (CMN)

QUICK START GUIDE

1. Turn on OLAS transmitters within 1 metre of the Guardian
2. Turn on power to the Guardian or press the control switch once
3. Wait for 30 seconds – check the number of sound and light signals represent the number of OLAS transmitters switched on within 1 metre
4. Download the OLAS mobile application and check battery status of all OLAS tags
5. **WARNING:** Always check the battery of any OLAS transmitter before leaving the dock. If a transmitter battery runs out whilst being used in the system it will cause the engine to immediately stop!
6. **CHECK BEFORE FIRST USE** - Run the engine in idle and place the OLAS transmitter at least 4 inches into open water (a cup or bucket will not be enough!)
7. The engine will cut out
8. Press the control switch once to Pause the alarm
9. After 5 seconds you will be able to operate the boat as normal
10. Bring the OLAS transmitter back within 1 metre and press the Guardians control switch once to reconnect
11. The Guardian can be switched off at any point by pressing the control switch for 4 seconds or when the power is disconnected. This will not stop the engine

OLAS TAG OPERATION

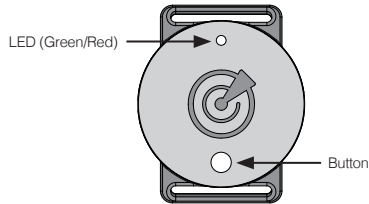

Switch ON:

Press the button for 4 seconds until the light flashes Green

Switch OFF:

Press the button for 4 seconds until the light flashes Red

Replacing the battery

DO NOT dispose of batteries in fire. Batteries should be recycled or disposed of as per your local guidelines.

Replace the lid ensuring the silicone insert is not damaged and the screws go through the holes correctly. DO NOT overtighten the screws.

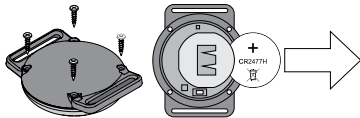

GUARDIAN FUNCTIONS

There are 3 operating states which can be applied to individual OLAS Transmitters using the OLAS mobile app:

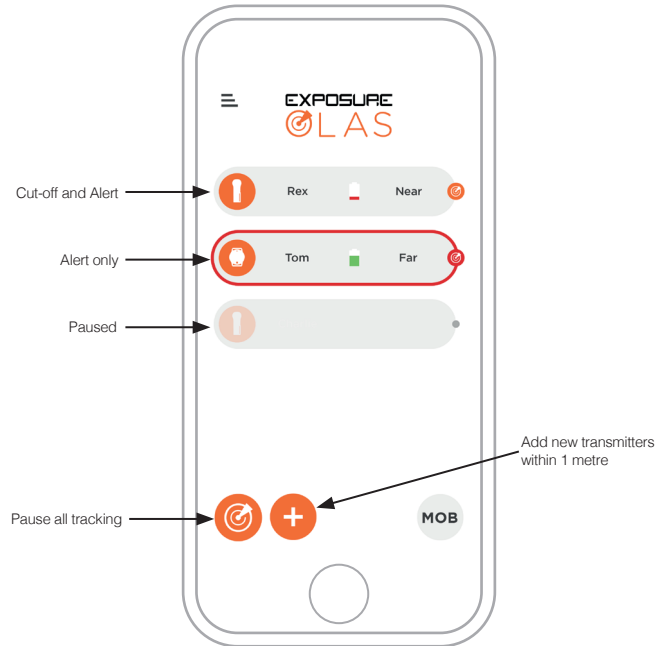

a. Cut-off and Alert (DEFAULT)

When an OLAS transmitter goes out of range, within 2 seconds the Guardian will cut-off the engine, sound its internal alert and trigger the MOB alert on the OLAS app. After 5 seconds the engine can be restarted by anyone remaining on the vessel

b. Alert

When an OLAS transmitter goes out of range, within 2 seconds the Guardian will sound its internal alert and trigger the MOB alert on the OLAS App. The engine will NOT cut-off and a rescue can be performed immediately. This mode should only be used for passengers

c. Paused

Pause state should be used when the user knows an OLAS transmitter will go out of range and they do not want the Guardian to react i.e. leaving the boat for an extended period or swimming

Index

1. Start up or returning to the vessel
2. Checking logged OLAS transmitters (without the OLAS mobile application)
3. Checking logged OLAS transmitters (with the OLAS mobile application)
4. OLAS mobile application features
5. Pause Tracking
6. Adding an OLAS transmitter (without the OLAS app)
7. Adding an OLAS transmitter (with the OLAS App)
8. Remove an OLAS transmitter
9. Low battery alert
10. Guardian override
11. Switching off the Guardian
12. Operating without OLAS transmitting devices
13. Recommendations

1. START UP OR RETURNING TO THE VESSEL

- Turn on all OLAS transmitters and place within 1 metre of the control switch
- Either switch on the power to the Guardian by activating the power supply or press the control switch once
- The control switch LED will illuminate Green with sound indication for 3 seconds
- The Guardian will scan for 30 seconds while the control switch LED flashes Green
- After 30 seconds, any OLAS transmitters within 1 metre of the Guardian will be logged
- The number of connected OLAS transmitters is then indicated with a sound signal and green flash per transmitter
- The control switch will illuminate green to indicate the Guardian is tracking

2. CHECKING LOGGED OLAS TRANSMITTERS (WITHOUT THE OLAS MOBILE APP)

- Press the control switch once
- The number of logged OLAS transmitters is indicated with a sound signal and green flash per transmitter

3. CHECKING LOGGED OLAS TRANSMITTERS (WITH THE OLAS MOBILE APP)

- Download and open the OLAS application from Google Play or the App store
- Select the Guardian from the device selection page
- All OLAS transmitters that are being tracked will be indicated on the home page

4. OLAS MOBILE APPLICATION FEATURES

- Customise the OLAS transmitters name
- Check OLAS tag battery status
- Enable/Disable cut-off switch for individual OLAS transmitters
- Enable/Disable OLAS transmitters
- Pause all tracking

5. PAUSE TRACKING

- Press the control switch for 2 seconds, release the control switch after a single beep
- When in Paused state the control switch will flash green for 3 seconds ON/3 seconds OFF followed by a sound signal
- Press the control switch once to re-start Tracking
- If an OLAS transmitter has been removed or switched off the Guardian will remain in Pause

6. ADDING AN OLAS TRANSMITTER (WITHOUT THE OLAS APP)

- Press the control switch for 2 seconds, release after a single beep, Tracking will be Paused
- Switch on the OLAS transmitter and hold it within 1 metre of the control switch
- Press the control switch once, the control switch will flash green for 10 seconds whilst scanning for new transmitters
- The number of connected OLAS transmitters is indicated with a sound signal and green flash per transmitter

7. ADDING AN OLAS TRANSMITTER (WITH THE OLAS APP)

- Switch on the OLAS transmitter and hold it within 1 metre of the control switch
- Open the home screen and press the + icon in the bottom corner
- The control switch will flash green for 10 seconds whilst scanning for new transmitters
- The number of connected OLAS transmitters is indicated with a sound signal and green flash per transmitter
- The home screen will update with the newly connected transmitters

8. REMOVE AN OLAS TRANSMITTER

- Press the control switch for 4 seconds, release after the second beep – this will switch off the Guardian
- Switch off the OLAS transmitter/s
- Hold all remaining OLAS transmitters within 1 metre of the control switch
- Press the control switch to switch the Guardian ON
- The Guardian will scan for 30 seconds while the control switch LED flashes green to indicate scanning
- After 30 seconds, any OLAS transmitter within 2 metres of the control switch will be tracked
- The number of connected OLAS transmitters is indicated with a sound signal and green flash per transmitter
- The control switch will illuminate green to indicate the Guardian is Tracking

9. LOW BATTERY ALERT

- A low battery alert will be initiated by the Guardian when an OLAS Tag's battery level goes below 20%
- The alert is indicated by a red flash every 10 seconds on the control switch and the Guardian Hub
- The alert will remain until the battery is changed
- You can check which OLAS tag has low battery using the OLAS app

Once you have located the tag you can **either**:

1. Pause the Guardian, change the battery and restart tracking
2. **Or** switch off the Guardian to remove the OLAS tag from the log, switch off the OLAS tag and restart the Guardian

10. GUARDIAN OVERRIDE

- When an OLAS transmitter goes out of range an alert will sound, the control switch will flash red and as a default setting the engine will cut-off
- After 5 seconds the engine can be started again so a rescue can be performed
- Press the control switch once to stop the alarm and pause the tracking
- Once the OLAS transmitter is back on the vessel and within 1 metre of the control switch, press the control switch once and tracking will continue
- **Pause will remain active if the OLAS transmitter that was lost is not back within 1 metre of the control switch**

11. SWITCHING OFF THE GUARDIAN

- The Guardian can be switched off at any point by pressing the control switch for 4 seconds
- The control switch will illuminate red with a sound signal before switching off

12. OPERATING WITHOUT OLAS TRANSMITTING DEVICES

- When switched ON the Guardian will automatically scan for OLAS transmitters
- If no transmitters are found the Guardian will emit an alert sound every second
- To override the Guardian, press the control switch for 4 seconds which will switch the Guardian off, your vessel will now operate normally.

WARNING: the cut-off switch and alarm will not operate!

ALWAYS WEAR A TRADITIONAL KILL CORD

13. RECOMMENDATIONS

- Switch off your OLAS transmitter if it is not going to be used for longer than 24 hours
- Check the battery life of the OLAS tags in the OLAS mobile application before you leave
- Check your OLAS Float-On's battery status before your journey and charge if required

LIMITATIONS

The connection signal can be blocked by carbon and metal. Operation on carbon or metal boats will require the Guardian box to be mounted externally.

SOUND AND LIGHT INDICATIONS

OPERATION	ACTION/REACTION	DURATION
Turning ON	Control switch - Green Box – Low red Buzzer ON	2 seconds
No OLAS transmitters in range	Control switch – Red Box – Low red Buzzer ON	Pulsing 0.5 seconds ON/OFF
Initial scan for OLAS transmitters within 1 metre	Control switch – Green Box – Low red	Pulsing 1 second ON/OFF for 30 seconds
Indication of logged OLAS transmitters	Control switch – Green Box – Low red Buzzer ON	Pulsing 0.5 seconds ON/OFF, 1 pulse per transmitter up to max 15
Tracking OLAS transmitters	Control switch – Green Control switch - Red	Continuous
MOB Alert	Box – High red Buzzer ON	Continuous lights Pulsing buzzer
Tracking paused	Control switch – Green Box – Low red Buzzer ON	Pulsing 3 second ON/OFF Buzzer once every 6 seconds
Scanning and logging transmitters within 1 metre	Control switch – Green Box – Low red	Pulsing 1 second ON/OFF
Low battery alert for OLAS tag NOTE: OLAS Float-On does not transmit battery status	Control switch – Red Box – Low red LED	Pulsing once every 10 seconds

SPECIFICATION

Power/Current	10-32V/13~17mA
Vessel length	50ft
Connected Transmitters	up to 15
Weight	110 grams
Size	92 x 90 x 38 mm
LED output	55lm
Buzzer output	85db

CERTIFICATIONS AND DECLARATIONS (OLAS GUARDIAN)

RoHS2 DIRECTIVE 2011/65/EU
(RED) (2014/53/EU)
EN 301 489-1 V2.1.1, EN 301 489-17 V3.1.1, EN 55032:2015
(CSPR 32:2015) and EN 55035: 2017 (CSPR 35: 2016)
EN 300 328 V2.1.1

FCC part 15b CFR47
ICES-003:2012

Contains Transmitter module FCC ID: QOQBGM13P
Contains Transmitter module IC: 5123A-BGM13P

CERTIFICATIONS AND DECLARATIONS (OLAS TAG)

RoHS2 DIRECTIVE 2011/65/EU
(RED) (2014/53/EU)

The full text of the EU declaration of conformity is available at the following internet address:
www.alertandfind.com/product-support

WARNING & WARRANTY

Any change or modification to this unit not expressly approved by the party responsible for compliance could void the user's authority to operate the equipment.

This equipment has been tested and found to comply with the limits for a Class B digital device, pursuant to Part 15 of the FCC Rules. These limits are designed to provide reasonable protection against harmful interference in a residential installation. This equipment generates, uses and can radiate radio frequency energy and, if not installed and used in accordance with the instructions, may cause harmful interference to radio communications. However, there is no guarantee that interference will not occur in a particular installation. If this equipment does cause harmful interference to radio or television reception, which can be determined by turning the equipment off and on, the user is encouraged to try and relocate the module.

This device complies with part 15 of the FCC Rules. Operation is subject to the following two conditions: (1) This device may not cause harmful interference, and (2) this device must accept any interference received, including interference that may cause undesired operation.

Ensure your phone or tablet has maximum volume, charged battery, GPS ON and Bluetooth ON.

Exposure Lights / Ultimate Sports Engineering Ltd. accept no liability for any injuries or other damages arising from the use of their product in any circumstances.

We design them. We make them. We are here to help.
If you are experiencing any problems with your OLAS product or accessories please contact us directly at:
Service: +44 (0)1798 839300 | service@use.group

Alternatively contact your Exposure OLAS dealer or distributor.
Check web for details www.alertandfind.com/product-support

TERMS & CONDITIONS

The OLAS systems are products from Ultimate Sports Engineering Ltd.
OLAS wireless systems utilise OLAS transmitters (OT) and OLAS receivers (OR).
OLAS transmitters consist of the OLAS tag and OLAS Float On.

OLAS receivers include the Guardian, the Core, the Extender and the OLAS mobile application (OLAS app)
Before using any OLAS wireless system it is imperative that you read the DISCLAIMER and the LIMITATION OF LIABILITY which follows. There is legal presumption that by using OLAS wireless systems you have read, understood and accepted the DISCLAIMER and the LIMITATION OF LIABILITY statement.

Setup

Start and setup all OLAS systems before you leave the dock and ensure all OTs are connected. Connecting the OLAS app allows visual indication of connected OTs.
Check the battery level of OLAS tags using the OLAS app. Check the battery level of OLAS Float-On's using the inbuilt colour coded battery indicator.

The OLAS App

Ensure GPS is running in the background on your mobile device. Keep your mobile device plugged in to a charger as GPS drains the battery. It is advised that the app is running in the foreground to enable maximum response time. It can take up to 30 second for the system to respond if the phone is in locked mode.

Test the Connection Whilst In Dock

Test the connection between the OR and the OT by leaving the OR in its planned location and walk the OT to the furthest point on the vessel. Check that all OT's being used are working correctly by submersing them in more the 4 inches of open water which will activate the alarm on the receiver.

Advice

As soon as a MOB situation occurs ensure a crew member keeps visual contact and points at the MOB. Contact the emergency services and give them the co-ordinates from your vessels GPS navigation system and the time since the MOB occurred.

Use OLAS Systems frequently as a practice aid for a MOB situation.

Disclaimer:

OLAS wireless systems are an aid only and should be used alongside existing safety products and procedures. They should not be used for navigation or lifesaving procedures. The OLAS app GPS coordinates cannot be relied upon to be accurate. Whilst accuracy of between 10-30 metres can be achieved, many factors can cause larger variations. The OLAS app cannot and does not take the external environment into consideration. Wind, tide, current and other factors will affect the position of the MOB.

The OLAS app can only assist you in getting back to the position that the automatic alert was issued. The OLAS app is not warranted to be accurate. GPS reception is variable and cannot be relied on. The phone can take up to 40 seconds to get a good GPS lock even when GPS connectivity is available.

The OLAS app will be more accurate if already running for 1 minute before grabbing the GPS location. It is advised that the app is running in the foreground to enable maximum response time. It can take up to 30 second for the system to respond if the phone is in locked mode. The OLAS App should only be used to complement other MOB methods and procedures.

Limitation of Liability:

In no event shall Ultimate Sports Engineering Ltd or its members, representatives or suppliers be liable for any damages whatsoever (including, without limitation, loss of property, personal injury, lost revenue, lost profits, loss of goodwill, business interruption) arising from or related to the use or inability to use or reliance on any OLAS wireless system, even if Ultimate Sports Engineering Ltd or its representatives or agents have been advised of the possibility of such damages. Some jurisdictions prohibit the exclusion or limitation of liability for implied warranties or consequential damages or incidental damages, so the above limitation may not apply to you. You may have other legal rights that vary from jurisdiction to jurisdiction. To the extent any liability is found, in no event will the liability of Ultimate Sports Engineering Ltd, its members, representatives or suppliers exceed the amount paid for the OLAS wireless system inclusive of the OLAS transmitters and receivers.

Patent Notice:

The OLAS wireless systems and associated products may be covered by patents or patent pending applications.

Credits Product: Ultimate Sports Engineering Ltd

Ultimate Sports Engineering Ltd
Unit 4 Bury Mill Farm
Bury
West Sussex
RH20 1NN
United Kingdom

